

4

3

2

1

Parts List

ITEM	QTY	PART NUMBER	DESCRIPTION	Fab Qty
1	1	PRT-2200-RB	1/2 NPT x 1/4 NPT STEEL REDUCER BUSHING	
2	1	PRT-2400-MT	1/2 x 18 GA STEEL Mechanical Tubing DOM	

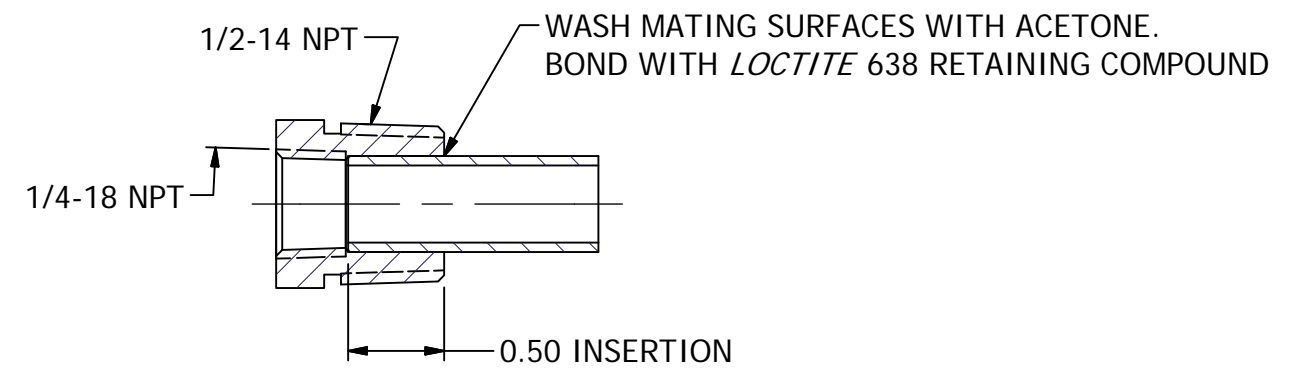

SECTION A-A

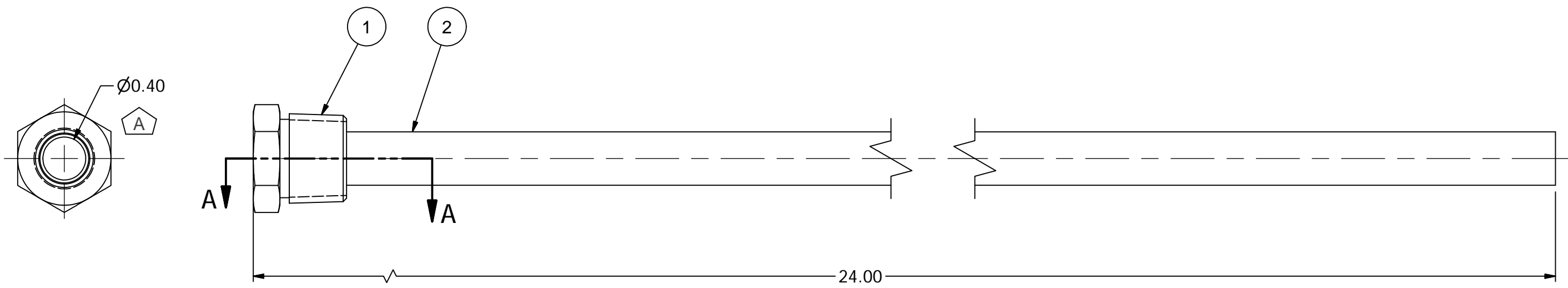

DATE	SYM.	DESCRIPTION	BY
1-13-11	A	TUBE WAS 16 GA	BPK

REVISIONS

AMERICAN MOBILE POWER PH: (800) 634-8265 FAX: (765) 948-3403	DRAWING BY: BPKNIGHT	DESIGN FOR: AMP	FILE NAME: PRT-2400	
	COMPLETED: 7/25/2007		SHEET: 1 of 3	SHEET SIZE: B

4

3

2

1

B

B

A

A